

## Grifería NT

- Cuerpo fabricado en latón estampado con acabado exterior cromado mate.
- Doble reglaje.

- Recorrido máximo del volante entre las posiciones cerrado-abierto de una sola vuelta.
- Posible cambio del mecanismo, sin necesidad de vaciar la instalación (Llave M-400).

- La rosca de enlace, incorpora una junta especial que permite el montaje directamente al emisor, sin necesidad de usar cáñamo o teflón.

- Montaje del enlace mediante llave hexagonal (Allen).
- Estanquidad enlace-cuerpo mediante arandela de plástico.

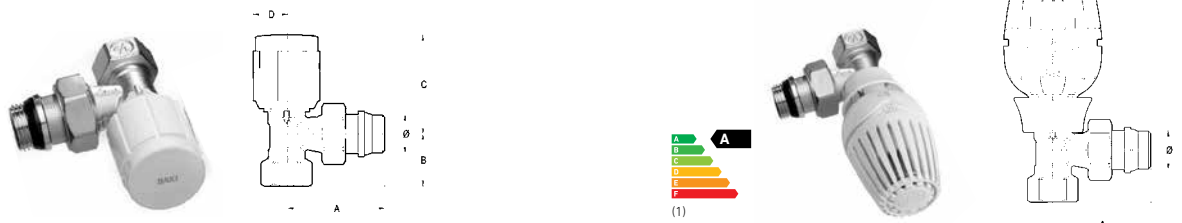

### Llave NT bitubo rosca hembra (escuadra)

Termostatizable			Termostática			
	3/8"	1/2"	3/4"	3/8"	1/2"	3/4"
Ø	3/8"	1/2"	3/4"	3/8"	1/2"	3/4"
A mm	49,5	53,5	62	49,5	53,5	62
B mm	27,5	28,5	24	27,5	28,5	24
C mm	52,4	52,5	52,5	110	110	110
D mm	18	18	18	27	27	27
Referencia	<b>193009019</b>	<b>193009020</b>	<b>193009021</b>	<b>193010013</b>	<b>193010014</b>	<b>193010015</b>
PVP	<b>7,80 €</b>	<b>8,75 €</b>	<b>14,20 €</b>	<b>18,30 €</b>	<b>19,30 €</b>	<b>24,70 €</b>

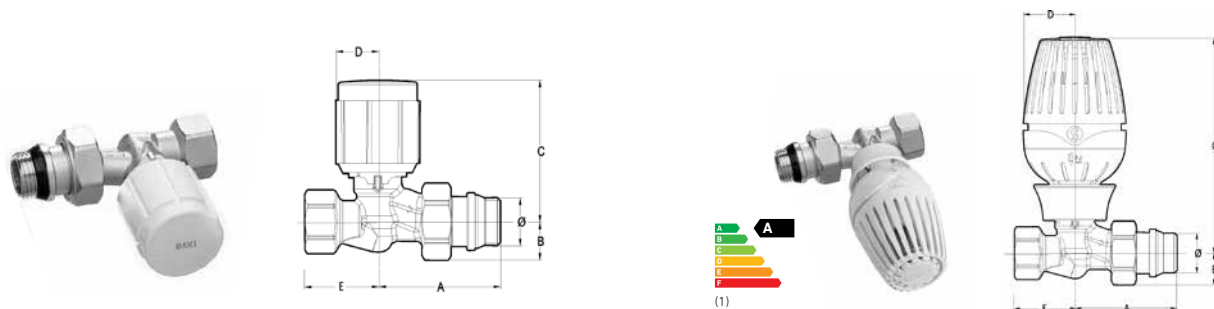

### Llave NT bitubo rosca hembra (recta)

Termostatizable			Termostática			
	3/8"	1/2"	3/4"	3/8"	1/2"	3/4"
Ø	3/8"	1/2"	3/4"	3/8"	1/2"	3/4"
A mm	51	54	56	51	54	56
B mm	12,5	15	20,5	12,5	15	20,5
C mm	60	60	60	110	110	110
D mm	18	18	18	27	27	27
E mm	29	32	27	29	32	27
Referencia	<b>193009022</b>	<b>193009023</b>	<b>193009024</b>	<b>193010016</b>	<b>193010017</b>	<b>193010018</b>
PVP	<b>8,55 €</b>	<b>9,90 €</b>	<b>15,05 €</b>	<b>19 €</b>	<b>20,40 €</b>	<b>25,50 €</b>

(1) Según TELL: Thermostatic Efficiency Label

- Posibilidad de termostatizarse fácilmente sustituyendo el volante manual por el cabezal termostático sin necesidad de vaciar la instalación.

- Temperatura máxima de trabajo: 110°C.
- Presión máxima de trabajo: 10 bar.



### Llave NT bitubo rosca macho (escuadra)

	Termostatizable		Termostática	
	M16	M18	M16	M18
Ø	1/2"	1/2"	1/2"	1/2"
A mm	54	54	54	54
B mm	21	21	21	21
C mm	59,5	59,5	110	110
D mm	17	17	27	27
M mm	16	18	16	18
Referencia	<b>193009030</b>	<b>193009031</b>	<b>193010024</b>	<b>193010025</b>
PVP	<b>8,75 €</b>	<b>9,45 €</b>	<b>19,30 €</b>	<b>19,95 €</b>

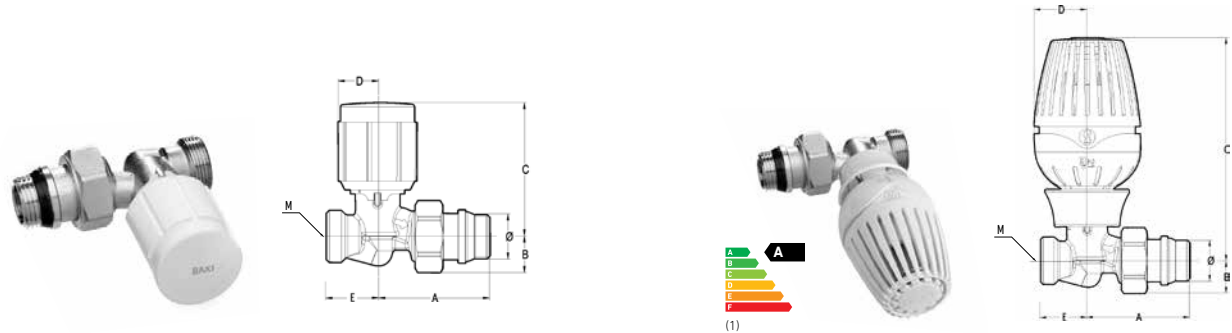

### Llave NT bitubo rosca macho (recta)

	Termostatizable		Termostática	
	M16	M18	M16	M18
Ø	1/2"	1/2"	1/2"	1/2"
A mm	51	51	51	51
B mm	17	17	17	17
C mm	58	58	110	110
D mm	22	22	27	27
E mm	23	23	23	23
M mm	16	18	16	18
Referencia	<b>193009032</b>	<b>193009033</b>	<b>193010026</b>	<b>193010027</b>
PVP	<b>9,90 €</b>	<b>10,35 €</b>	<b>20,40 €</b>	<b>20,90 €</b>

(1) Según TELL: Thermostatic Efficiency Label

## Grifería NT

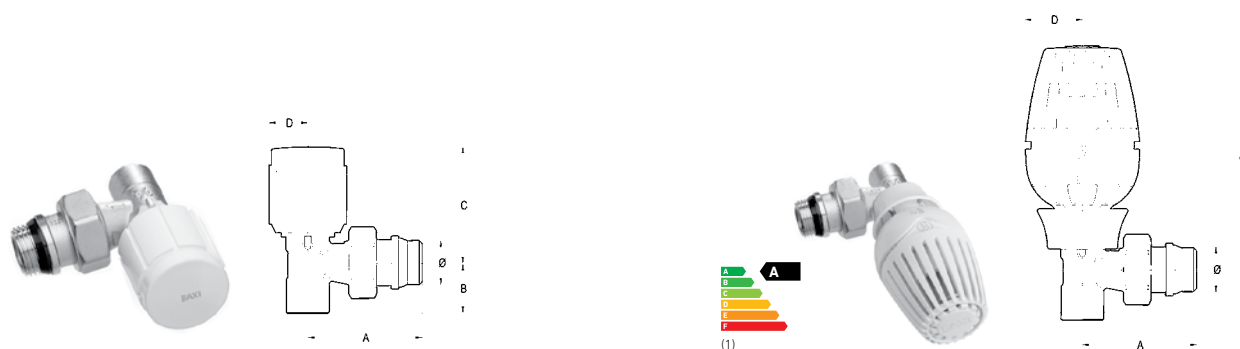

### Llave NT bitubo soldar (escuadra)

	Termostatizable					Termostática				
Tubo de cobre	10-12	12-14	12-14	13-15	14-16	10-12	12-14	12-14	13-15	14-16
Ø	3/8"	3/8"	1/2"	1/2"	1/2"	3/8"	3/8"	1/2"	1/2"	1/2"
A mm	49	49	54	54	54	49	49	54	54	54
B mm	21,5	22,5	22,5	23	23,5	21,5	22,5	22,5	23	23,5
C mm	52,5	52,5	52,5	52,5	52,5	110	110	110	110	110
D mm	18	18	18	18	18	27	27	27	27	27
Referencia	<b>193009025</b>	<b>193009026</b>	<b>193009027</b>	<b>193009028</b>	<b>193009029</b>	<b>193010019</b>	<b>193010020</b>	<b>193010021</b>	<b>193010022</b>	<b>193010023</b>
PVP	<b>7,80 €</b>	<b>7,80 €</b>	<b>8,75 €</b>	<b>8,75 €</b>	<b>8,75 €</b>	<b>18,30 €</b>	<b>18,30 €</b>	<b>19,30 €</b>	<b>19,30 €</b>	<b>19,30 €</b>



### Llave NTB bitubo rosca macho

	Termostatizable	Termostática
Ø	1/2"	1/2"
Métrica	16	16
Referencia	<b>193021000</b>	<b>193010033</b>
PVP	<b>14,65 €</b>	<b>25,20 €</b>

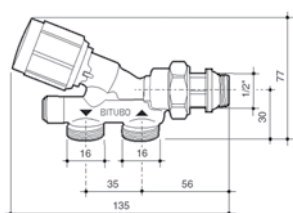

(1) Según TELL: Thermostatic Efficiency Label



## Llave NT monotubo rosca macho

### Escuadra

	Termostatizable	Termostática
Ø	1/2"	1/2"
Métrica	18	18
A mm	130	260
B mm	58	58
C mm	45	120
D mm	50	50
E mm	35	35
F mm	7	7
Referencia	<b>193008011</b>	<b>193010029</b>
PVP	<b>16,65 €</b>	<b>27,20 €</b>

### Vertical

	Termostatizable		Termostática	
Ø	1/2"	1/2"	1/2"	1/2"
Métrica	16	18	16	18
A mm	57	57	57	57
B mm	54	50	54	50
C mm	52,5	41	120	120
D mm	35	50	35	50
E mm	26	22	26	22
F mm	11	7	11	7
Referencia	<b>193008012</b>	<b>193008013</b>	<b>193010030</b>	<b>193010031</b>
PVP	<b>15,55 €</b>	<b>16,65 €</b>	<b>25,90 €</b>	<b>27,20 €</b>

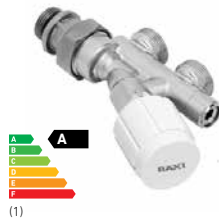
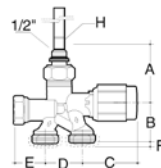
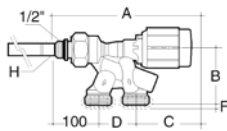

## Llave NTM monotubo reversible rosca macho

	Termostatizable	Termostática
Ø	1/2"	1/2"
Métrica	16	16
Referencia	<b>193008016</b>	<b>193010032</b>
PVP	<b>14,65 €</b>	<b>25,20 €</b>

## Llave NT monotubo vertical escuadra rosca macho

	Termostatizable derecha	Termostatizable izquierda
Ø	1/2"	1/2"
Métrica	16	16
Referencia	<b>193008017</b>	<b>193008018</b>
PVP	<b>18,80 €</b>	<b>18,80 €</b>

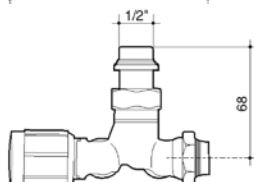
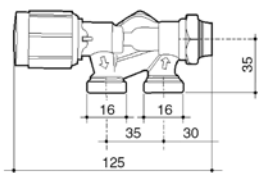
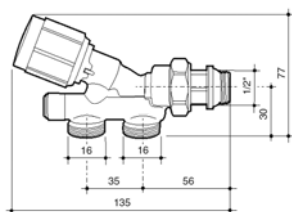

(1) Según TELL: Thermostatic Efficiency Label